

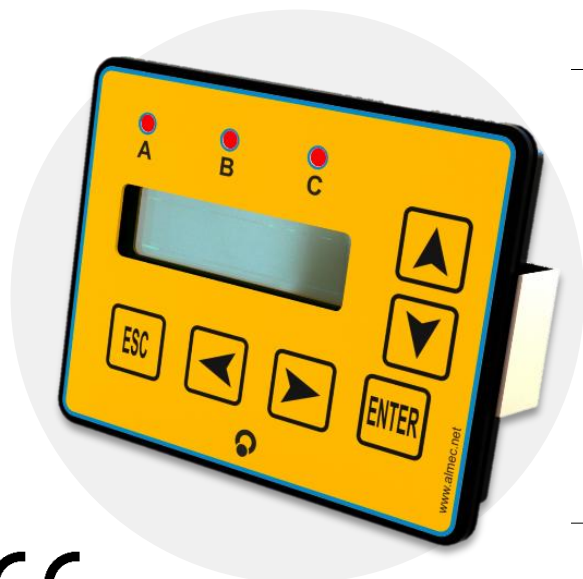

ALMPO SMALL

16x2 CHARACTER HMI



All versions:

- HMI designed for diagnosis, parametrization and control applications
- CAN BUS or SERIAL network
- Up to 6 key keyboards with backlight
- 16x2 characters display
- Customizable graphics label
- Equipped with 8 I/O



the image is for illustrative purposes only

TECHNICAL DATA

	BASIC VERSION	FULL VERSION
CODE	ALMPO.B	ALMPO.F
POWER SUPPLY	9 ÷ 36 VDC	
INPUT	NO	N.2 DIGITAL INPUTS HIGH SIDE
OUTPUT	NO	N.2 DIGITAL HIGH SIDE OUTPUT (MAX 1 A MAX)
BUTTON	N. 6 FRONTAL KEYS (WITH BACKLIGHT)	
LED	N. 3 PROGRAMMABLE LEDES	UP TO 6 PROGRAMMABLE SPOTLIGHT LEDES BUTTON'S (ON REQUEST)
CAN BUS	N.1 PORT: 2.0 A/B COMPLIANT - (11, 29 BIT) - ISO 11898 - UP TO 1MBIT/S* PROTOCOL: CAN OPEN (CIA DS401 DEVICE PROFILE FOR GENERIC I/O MODULE, WITH DS306 EDS FILE)	
SERIAL (ON REQUEST)	N.1 SERIAL PORT CONNECTION TTL THE DEVICE CAN ONLY SUPORT CAN PORT OR SERIAL PORT	
DISPLAY	LCD TYPE: MONOCROMATIC FSTN 16 CHARACTERS X 2 LINES VISUAL AREA: 64.6 (W) X 16.0 (H)	
BUZZER	OPTIONAL	YES
CONNECTIONS	N.1 - M12 4 PIN MALE CONNECTOR	N.1 - M12 8 PIN MALE CONNECTOR
WORKING TEMPERATURE	-20°C +70°C	
MATERIAL	ENCLOSURE: ABS UL94 V0	



(20/02/2026) - 1



ALMPO SMALL

16x2 CHARACTER HMI

ELECTRONIC FEATURES

SLAVE USAGE	EDS FILE
PROGRAMMING	FIRMWARE UPLOAD BY CAN BUS WITH ALOADER SOFTWARE TOOL
CPU	FAMILY: ARM CORTEX M4, 32 bit MICROCONTROLLER CORE

STANDARDS

ELECTROMAGNETIC (EMC)	ACCORDING TO DIRECTIVE 2014/30/EU:
	EN 61000-6-4
	EN 61000-6-2 EN 50498

PROTECTION	IP 65 ON THE FRONTAL KEYBOARD
-------------------	-------------------------------

IN ACCORDANCE WITH THE EN50498 THE DEVICE MEETS THE TECHNICAL SPECIFIC REQUIREMENTS OF 2004-104 DIRECTIVE (AUTOMOTIVE). THE DEVICE IS EMC 2004/108 COMPLIANT.

SIZE (mm)

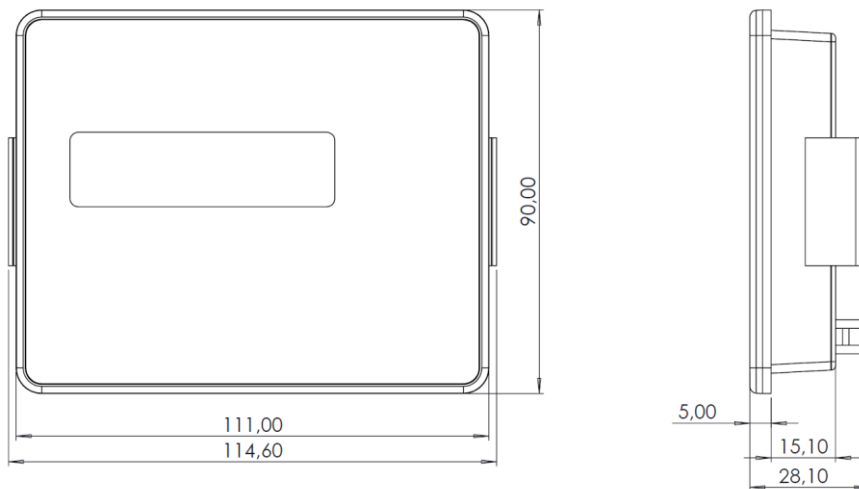

ELECTRICAL CONNECTION

BASIC VERSION

- 1 POSITIVE POWER SUPPLY
- 2 CAN L / RS232 TX
- 3 NEGATIVE POWER SUPPLY
- 4 CAN H / RS232 RX

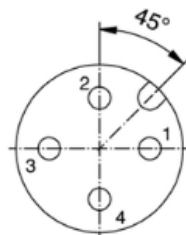

FULL VERSION

- 1 POSITIVE POWER SUPPLY
- 2 IN 1
- 3 CAN H / RS232 RX
- 4 IN 2
- 5 NEGATIVE POWER SUPPLY
- 6 OUT 1
- 7 CAN L / RS232 TX
- 8 OUT 2

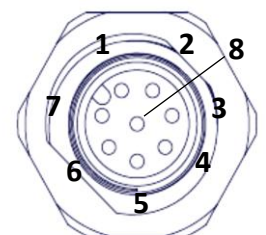



ALMPO SMALL

16x2 CHARACTER HMI

FEATURES

BASIC VERSION

DEVICE CONFIGURATION

- A. PUSHBUTTON WITH BAKCLIGHT (6 TOTAL)
- B. RED MONOCROME LED (6 TOTAL)
- C. CUSTOMIZABLE GRAPHIC LABEL
- D. 16x2 CHARACTER DISPLAY

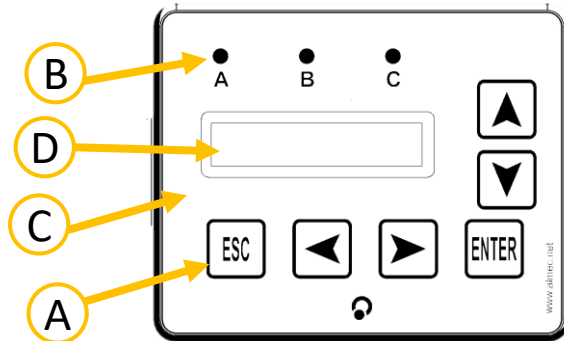

FULL VERSION

DEVICE CONFIGURATION

- A. CUSTOMIZABLE GRAPHIC LABEL
- B. 16x2 CHARACTER DISPLAY
- C. INTEGRATED RED SPOTLIGHT BUTTON (x TOTAL)

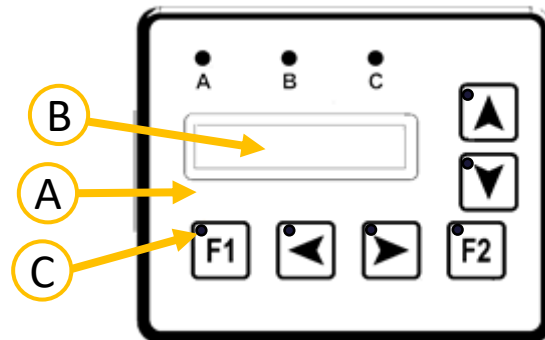

CUSTOMIZABLE KEYBOARD LABEL

pictograms and company logos

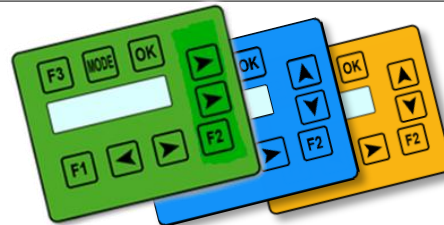

INSTALLATION

PANEL MOUNTING, WITH WALL MOUNT BRACKET INCLUDED

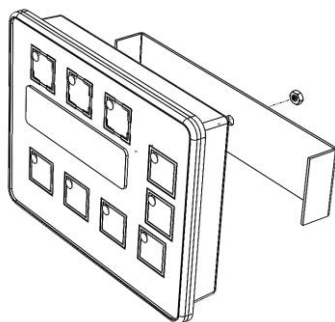

PANEL CUTOUT



PANEL THICKNESS: MIN: 0,8mm – MAX: 4 mm

INCLUDED: ADHESIVE RUBBER GASKET FOR WATER TIGHTNESS



NOTE